









HARDWARE LIST			
1		Flat washer	18PCS
2		Short Bolt	5PCS
3		Long Bolt	13PCS
4		Shelf Support	12PCS
PARTS LIST			
A		Main Body	1PC
C		Under crossbar	4PCS
E		Upper crossbar	1PC
G		Side adjustable shelf	2PCS
I		Center vertical panel	2PCS
B		Fixed Shelf	1PC
D		Back Panel	1PC
F		Top Panel	1PC
H		Center adjustable shelf	1PC
		Allen Wrench	1PC
		Screw	2PCS
		Long Bolt	13PCS
		Metal connector	2PCS

ASSEMBLY INSTRUCTION  
FOR ITEM NO. 7654

ASSEMBLY INSTRUCTION  
FOR ITEM NO. 7654

STEP: 1

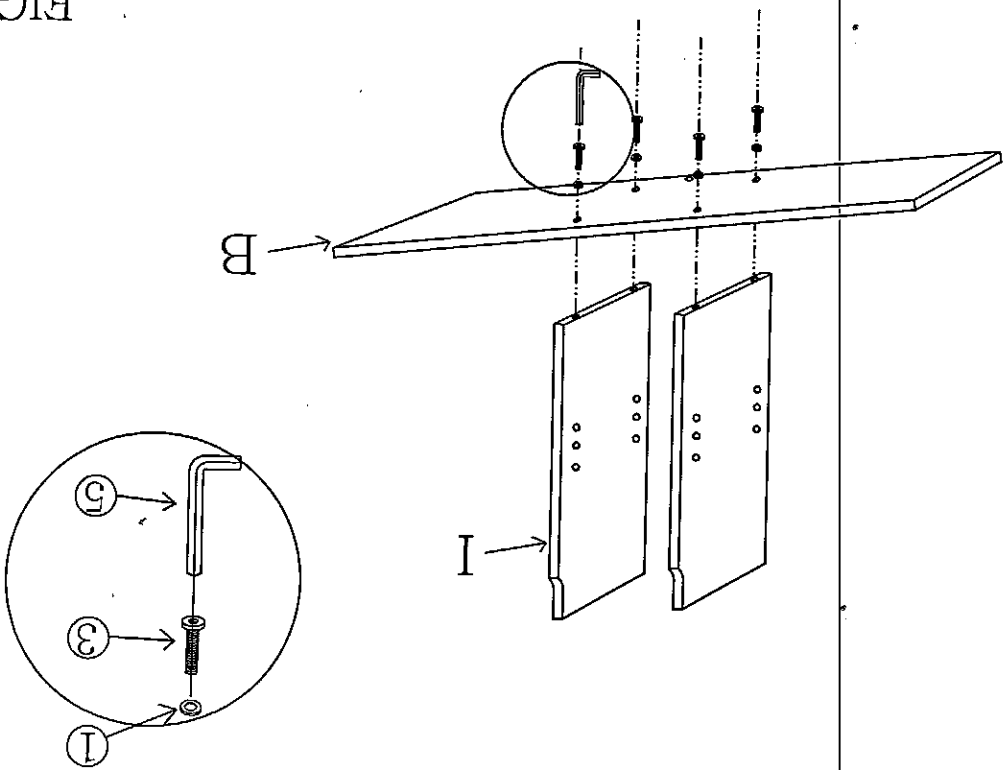
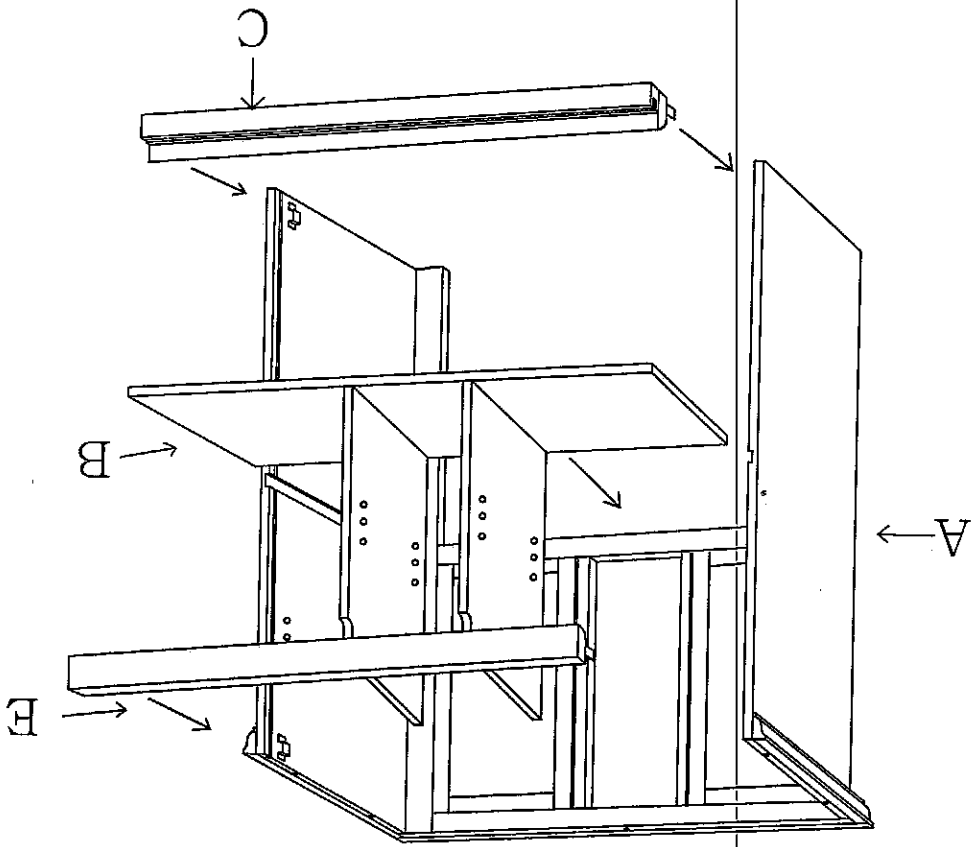

FIG. 2.

STEP: 2



ASSEMBLY INSTRUCTION  
FOR ITEM NO. 7654

STEP: 3

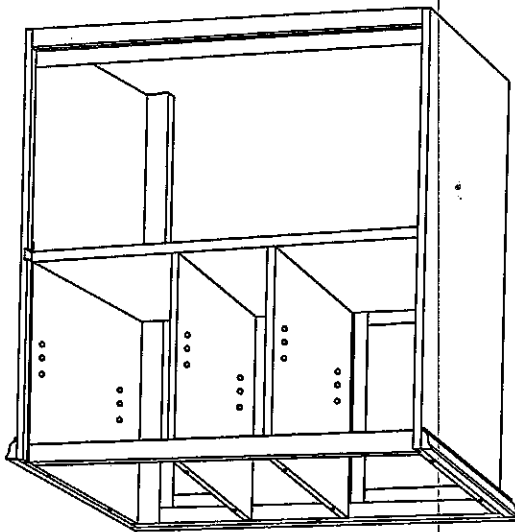
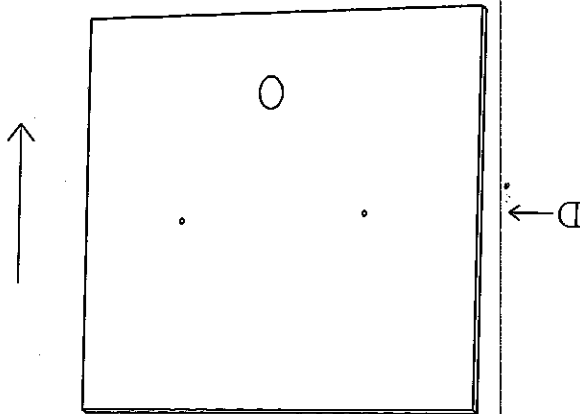
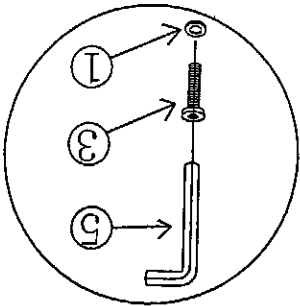
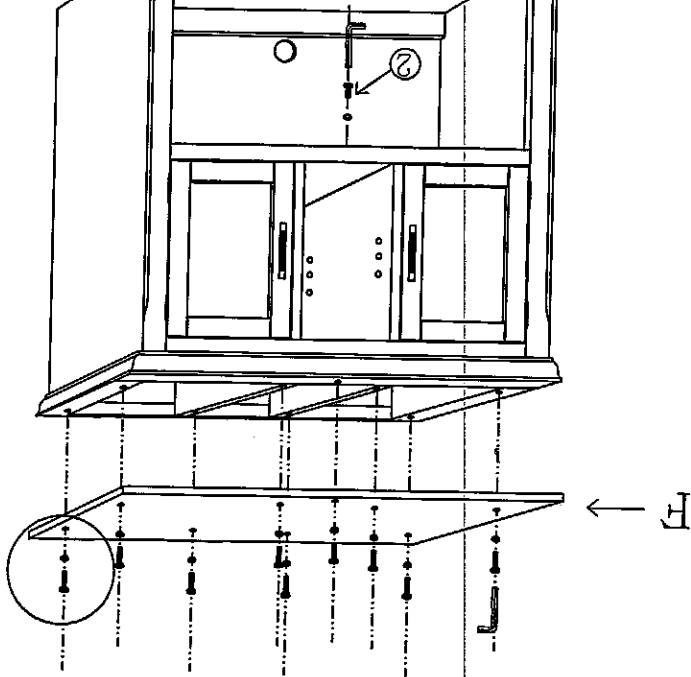

FIG. 4.

STEP: 4



ASSEMBLY INSTRUCTION  
FOR ITEM NO. 7654

STEP: 5

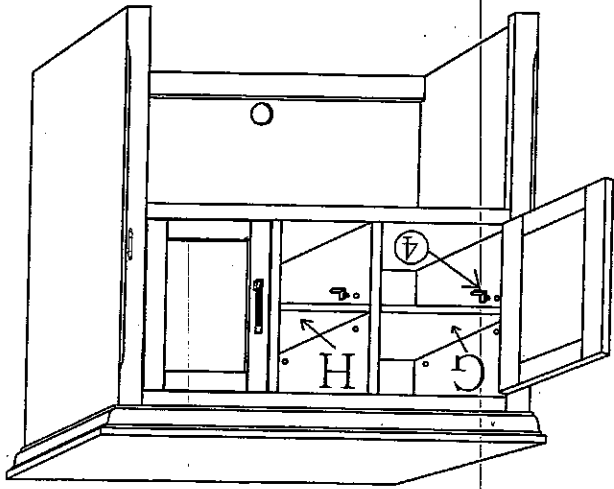

FIG. 6.

STEP: 6

